

SOD-3 23 Plastic-Encapsulate Diodes

FEATURES

- Fast Switching Speed
- Surface Mount Package Ideally Suited for Automatic Insertion
- For General Purpose Switching Applications
- High Conductance

MARKING: T4

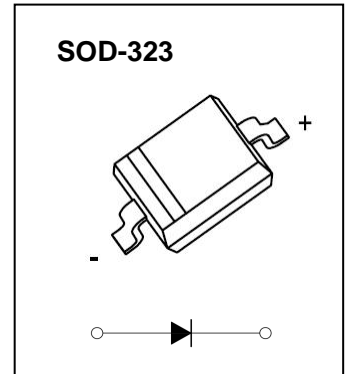

Maximum Ratings and Electrical Characteristics, Single Diode @T_a=25°C

Parameter	Symbol	Limit	Unit
Non-Repetitive Peak Reverse Voltage	V _{RM}	100	V
Peak Repetitive Peak Reverse Voltage	V _{RRM}		
Working Peak Reverse Voltage	V _{RWM}	100	V
DC Blocking Voltage	V _R		
RMS Reverse Voltage	V _{R(RMS)}	71	V
Forward Continuous Current	I _{FM}	300	mA
Average Rectified Output Current	I _O	150	mA
Non-Repetitive Peak Forward Surge Current @t=8.3ms	I _{FSM}	2.0	A
Power Dissipation	P _d	200	mW
Thermal Resistance from Junction to Ambient	R _{θJA}	625	°C/W
Junction Temperature	T _j	150	°C
Storage Temperature	T _{STG}	-55~+150	°C

ELECTRICAL CHARACTERISTICS

Electrical Ratings @Ta=25°C

Parameter	Symbol	Min	Typ	Max	Unit	Conditions
Forward voltage	V _{F1}			0.715	V	I _F =1mA
	V _{F2}			0.855	V	I _F =10mA
	V _{F3}			1.0	V	I _F =50mA
	V _{F4}			1.25	V	I _F =150mA
Reverse current	I _{R1}			1	μA	V _R =75V
	I _{R2}			25	nA	V _R =20V
Capacitance between terminals	C _T			2	pF	V _R =0V, f=1MHz
Reverse recovery time	t _{rr}			4	ns	I _F =I _R =10mA I _{rr} =0.1X I _R , R _L =100Ω

Typical Characteristics

Forward Characteristics

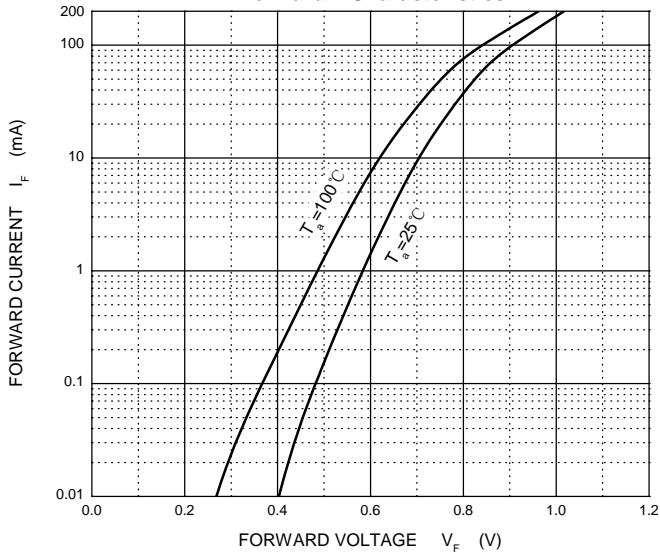

Reverse Characteristics

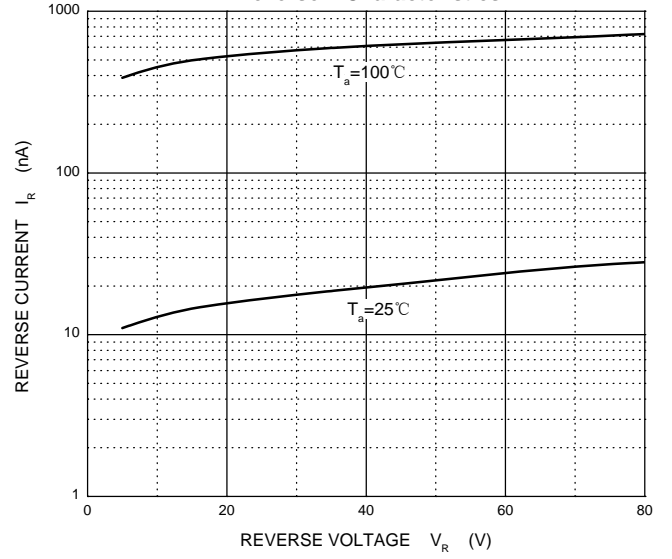

Capacitance Characteristics

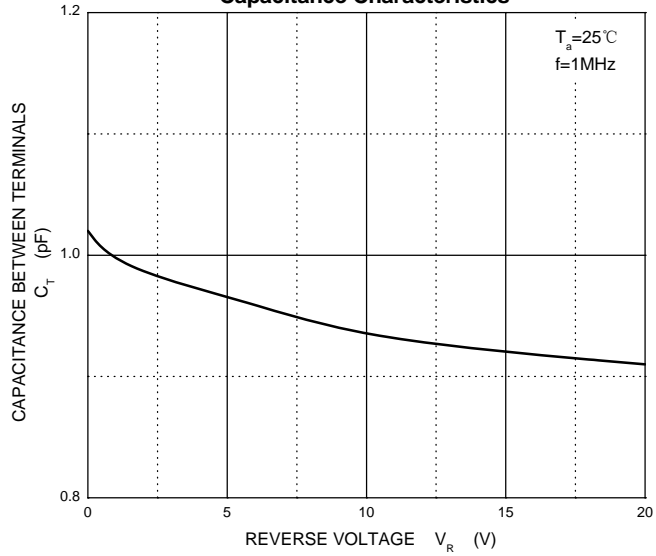

Power Derating Curve

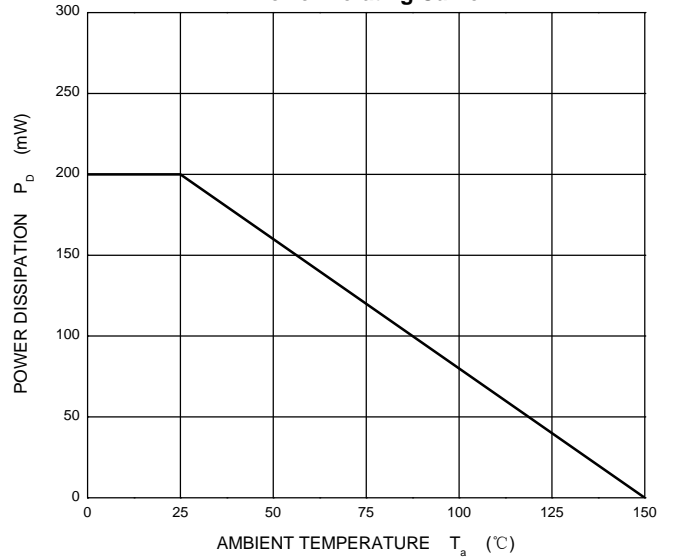

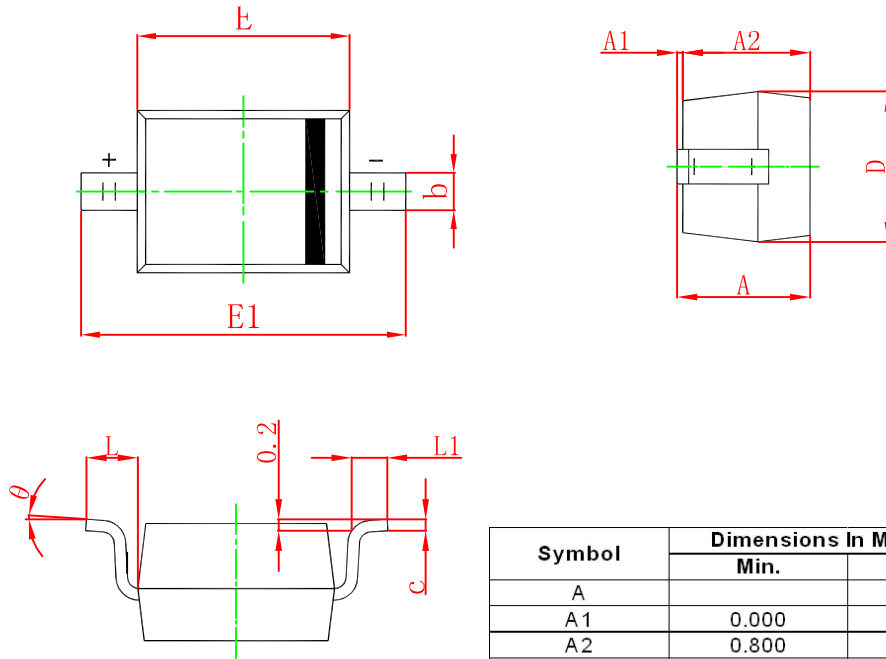

Symbol	Dimensions In Millimeters		Dimensions In Inches	
	Min.	Max.	Min.	Max.
A		1.000		0.039
A1	0.000	0.100	0.000	0.004
A2	0.800	0.900	0.031	0.035
b	0.250	0.350	0.010	0.014
c	0.080	0.150	0.003	0.006
D	1.200	1.400	0.047	0.055
E	1.600	1.800	0.063	0.071
E1	2.550	2.750	0.100	0.108
L	0.475 REF.		0.019 REF.	
L1	0.250	0.400	0.010	0.016
θ	0°	8°	0°	8°

SOD-323 Suggested Pad Layout

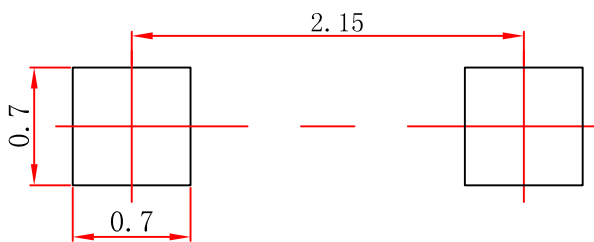

Note:

1. Controlling dimension: in millimeters.
2. General tolerance: ± 0.05 mm.
3. The pad layout is for reference purposes only.